

Model 7756D



Features

- Complete software radio interface solution
- Two or four 400 MHz, 14-bit A/Ds
- One or two DUCs (Digital Upconverters)
- Two or four 800 MHz, 16-bit D/As
- Up to 2 GB of DDR2 SDRAM
- Two or four Xilinx Virtex-5 FPGAs
- Dual timing buses for independent A/D and D/A clock rates
- LVPECL clock/sync bus for multiboard synchronization
- 32 or 64 pairs of LVDS connections to the Virtex-5 FPGAs for custom I/O

General Information

Model 7756 is a PCIe board that includes two 400 MHz A/Ds, 800 MHz D/As and Virtex-5 FPGAs. It consists of one Model 7156 transceiver mounted on a PCIe carrier. Model 7756D is the same as the Model 7752, except it contains two 7156's rather than one.

A/D Converter Stage

The front end accepts two or four full scale analog HF or IF inputs on front panel SMC connectors at +8 dBm into 50 ohms with transformer coupling into TI ADS5474 14-bit 400 MHz A/Ds. Designed with a 750 MHz input bandwidth, the A/Ds are excellent for undersampling applications.

The digital outputs are delivered into the Virtex-5 processing FPGA for signal processing, data capture or routing to other board resources.

Digital Upconverter and D/A Stage

A TI DAC5688 digital upconverter (DUC) and D/A accepts a baseband real or complex data stream from the FPGA and provides that input to the upconvert, interpolate and dual D/A stages.

When operating as an upconverter, it interpolates and translates real or complex baseband input signals to any IF center frequency between DC and 250 MHz. It delivers real or quadrature (I+Q) outputs at up to 500 MHz to the 16-bit D/A converter. Analog output is through a pair of front panel SMC connectors at +4 dBm into 50 ohms. If translation is disabled, the DAC5688 acts as a dual interpolating 16-bit D/A with output sampling rates up to 800 MHz. In both modes the DAC5688 provides interpolation factors of 2x, 4x and 8x.

Virtex-5 FPGAs

The architecture includes two or four Virtex-5 FPGAs. All of the board's data and control paths are accessible by the FPGAs, enabling factory-installed functions including data multiplexing, channel selection, data packing, gating, triggering and SDRAM memory control. In addition to the built-in functions, users can install their own custom IP for data processing. Pentek GateFlow FPGA Design Kits facilitate integration of user-created IP with the factory shipped functions.

The processing FPGA serves as a control and status engine with data and programming interfaces to each of the on-board resources including the data converters, DDR2 SDRAM memory, interface FPGA, programmable LVDS I/O and clock, gate and synchronization circuits. The processing FPGA can be populated with a variety of different FPGAs to match the specific requirements of the processing task. Supported FPGAs include: Virtex-5 SX50T, SX95T, LX50T, LX155T, and FX100T.

The SXT parts feature between 288 and 640 DSP48E slices and are ideal for demodulation/modulation, decoding/encoding, decryption/encryption, digital delay, and channelization of the signals between reception and transmission. For applications requiring more FPGA logic cells, the board can be optionally configured with an LX155T in the processing FPGA position for 156,648 logic cells.

A second Virtex-5 FPGA provides the board's PCI-X interface. Implementing the interface in this second FPGA keeps the processing FPGA resources free for signal processing. The interface FPGA can be configured as an LXT family or an SXT family

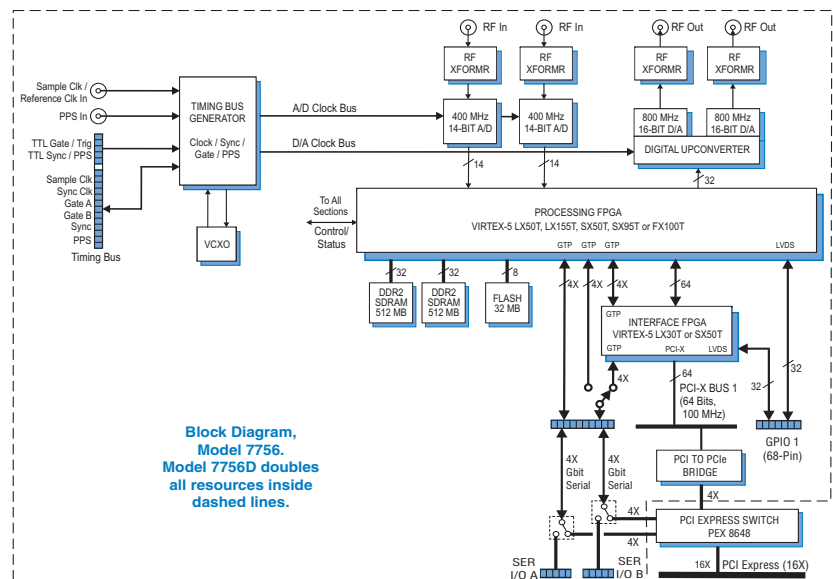

PCI Express Interface

The 7756 includes a multiple port, 48-lane Gen 2 PCIe switch with integrated SerDes. The switch provides 16X wide connection to the PCIe interface, allowing high-speed data transfers to and from the motherboard. Switch ports include buffer memory to minimize bottlenecks. Two 4X PCIe connections are provided to each FPGA, as well as one 4X connection to each 64-bit PCI-X interface.

The optional Gigabit Serial I/O provides two full-duplex 4X paths (Model 7756) or four full-duplex 4X paths (Model 7756D) through connectors mounted at the top of the board.

Ordering Information

Model	Description
7756	Dual 400 MHz A/D, 800 MHz D/A, Virtex-5 FPGAs - PCIe
7756D	Quad 400 MHz A/D, 800 MHz D/A, Virtex-5 FPGAs - PCIe
Options:	
-104	FPGA I/O through the GPIO connector(s)
-5xx	Gigabit Serial I/O: two full-duplex 4X paths (Model 7756) or four full duplex-4X paths (Model 7756D)

Contact Pentek for additional available options.

► part, providing not only interface functionality, but processing resources up to an additional 640 DSP48E slices.

Option -104 installs a GPIO connector with 16 pairs of LVDS connections to each processing FPGA, and 16 pairs of LVDS connections to each interface FPGA for custom I/O.

Clocking and Synchronization

Two internal timing buses can provide either a single clock or two different clock rates to the A/D and D/A signal paths.

Each timing bus includes a clock, sync and a gate or trigger signal. An internal clock generator receives an external sample clock from the front panel SMC connector. This clock can be used directly for either the A/D or D/A sections or can be divided by a built-in clock synthesizer circuit to provide different A/D and D/A clocks. In an alternate mode, the sample clock can be sourced from an on-board programmable voltage controlled crystal oscillator. In this mode, the front panel SMC connector can be used to provide a 10 MHz system reference clock for synchronizing the internal oscillator.

A front panel 26-pin LVPECL Clock/Sync connector allows multiple boards to be synchronized. In the slave mode, it accepts LVPECL inputs that drive the clock, sync and gate signals. In the master mode, the LVPECL bus can drive the timing signals for synchronizing multiple modules.

Up to two slave 7756D's and three slave 7756's can be driven from the LVPECL bus master, supporting synchronous sampling and sync functions across all connected boards.

Memory Resources

Up to four independent 512 MB banks of DDR2 SDRAM are available to the processing FPGAs. Built-in memory functions include an A/D data transient capture mode with pre- and post-triggering and D/A waveform playback mode. All memory banks are supported with DMA engines for easily moving data through the PCI interface.

Specifications

Front Panel Analog Signal Inputs

Input Type: Transformer-coupled, front panel female SMC connectors

Full Scale Input: +8 dBm into 50 ohms

3 dB Passband: 250 kHz to 750 MHz

A/D Converters

Type: TI ADS5474

Sampling Rate: 20 MHz to 400 MHz

Resolution: 14 bits

D/A Converters

Type: TI DAC5688

Input Data Rate: 250 MHz max.

Output IF: DC to 300 MHz

Output Signal: 2-channel real or

1-channel with frequency translation

Output Sampling Rate: 800 MHz max. with interpolation

Resolution: 16 bits

Front Panel Analog Signal Outputs

Output Type: Transformer-coupled, front panel female SMC connectors

Full Scale Output: +4 dBm into 50 ohms

3 dB Passband: 250 kHz to 750 MHz

Sample Clock Sources: On-board clock synthesizer generates two clocks: one A/D clock and one D/A clock

Clock Synthesizer:

Clocks Source: Selectable from on-board programmable VCXO, front panel external clock or LVPECL timing bus

Synchronization: Clocks can be locked to a front panel 5 or 10 MHz system reference

External Clocks

Type: Front panel female SMC connector, sine wave, 0 to +10 dBm, AC-coupled, 50 ohms, accepts 20 to 400 MHz sample clock or 10 MHz system reference

Timing Bus: 26-pin connector LVPECL bus includes clock/sync/gate/PPS input/output; TTL signals for gate/trigger and sync/PPS inputs

Field Programmable Gate Arrays

Processing FPGA: Xilinx Virtex-5 XC5VSX50T; optional FPGAs include: XC5VLX50T, XC5VSX95T, XC5VFX100T, or XC5VLX155T

Interface FPGA: Xilinx Virtex-5 XC5VLX30T; optional FPGA: XC5VSX50T or XC5VFX70T

Custom I/O

Available only with SX95T, LX155T and FX100T FPGAs

Option -104: Provides GPIO with 16 LVDS pairs to each processing FPGA and 16 pairs to each interface FPGA

Memory

DDR2 SDRAM: Up to 1.0 GB in two banks per processing FPGA (2 GB max.)

PCI to PCIe Interface

PCI-X Bus: 64-bits, 100 MHz and 64- or 32-bits at 33 or 66 MHz

DMA: 4 channel demand-mode and chaining controller per PCI bus

PCIe Interface: Gen. 2, 16X width

PCIe Ports: two 4X ports per FPGA; one 4X port per PCI bus; one 16X port to PCIe motherboard

Environmental

Operating Temp: 0° to 50° C

Storage Temp: -20° to 90° C

Relative Humidity: 0 to 95%, non-cond.

Size: Full-length PCIe, 4.38 in. x 12.3 in.